

IMPORTANT

DO NOT DRILL TIMBER
 Do not drill timber. Refer to joist profile plots for maximum joist spacing.

DO NOT CUT TIMBER
 Do not cut timber. Refer to joist profile plots for maximum joist spacing.

DO NOT DAMAGE OR REMOVE WEBS
 Do not damage or remove webs. Refer to joist profile plots for maximum joist spacing.

DO NOT EXPOSE TO EXCESSIVE MOISTURE
 Do not expose to excessive moisture. Refer to joist profile plots for maximum joist spacing.

DO NOT NOTCH ENDS IF REQUIRED SERVICES
 Do not notch ends if required services. Refer to joist profile plots for maximum joist spacing.

DO USE WEB OPENINGS FOR SERVICES
 Do use web openings for services. Refer to joist profile plots for maximum joist spacing.

DO CUT TRIMMABLE ENDS IF REQUIRED SERVICES
 Do cut trimmable ends if required services. Refer to joist profile plots for maximum joist spacing.

DO SPACE CORRECTLY
 Do space correctly. Refer to joist profile plots for maximum joist spacing.

DO ORIENT CORRECTLY
 Do orient correctly. Refer to joist profile plots for maximum joist spacing.

DO NOT EXPOSE TO EXCESSIVE MOISTURE
 Do not expose to excessive moisture. Refer to joist profile plots for maximum joist spacing.

DO NOT DRILL TIMBER
 Do not drill timber. Refer to joist profile plots for maximum joist spacing.

DO NOT CUT TIMBER
 Do not cut timber. Refer to joist profile plots for maximum joist spacing.

DO NOT DAMAGE OR REMOVE WEBS
 Do not damage or remove webs. Refer to joist profile plots for maximum joist spacing.

DO NOT EXPOSE TO EXCESSIVE MOISTURE
 Do not expose to excessive moisture. Refer to joist profile plots for maximum joist spacing.

DO NOT NOTCH ENDS IF REQUIRED SERVICES
 Do not notch ends if required services. Refer to joist profile plots for maximum joist spacing.

DO USE WEB OPENINGS FOR SERVICES
 Do use web openings for services. Refer to joist profile plots for maximum joist spacing.

DO CUT TRIMMABLE ENDS IF REQUIRED SERVICES
 Do cut trimmable ends if required services. Refer to joist profile plots for maximum joist spacing.

DO SPACE CORRECTLY
 Do space correctly. Refer to joist profile plots for maximum joist spacing.

DO ORIENT CORRECTLY
 Do orient correctly. Refer to joist profile plots for maximum joist spacing.

IMPORTANT
 Modification of joists is strictly prohibited. The floor system as a whole.

Pitched Roofs

easi-joist® can easily be adapted to create pitched roof structures as a lighter, more thermally efficient alternative to solid sawn timber. By redesigning the end column configuration, the **easi-joist®** system can be installed onto a wallplate or ridge beam without the need for a bevelled wallplate or special metalwork items. This versatile connection detail enables top and bottom supports to accommodate a range of bearing widths and can also incorporate intermediate supports.

Using joists for roof structures requires consideration of external load factors and more complex geometry at eaves and ridge locations.

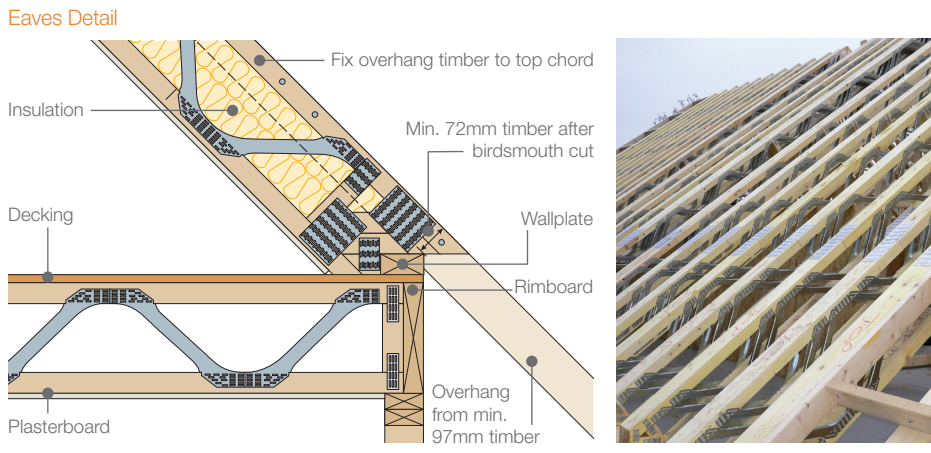
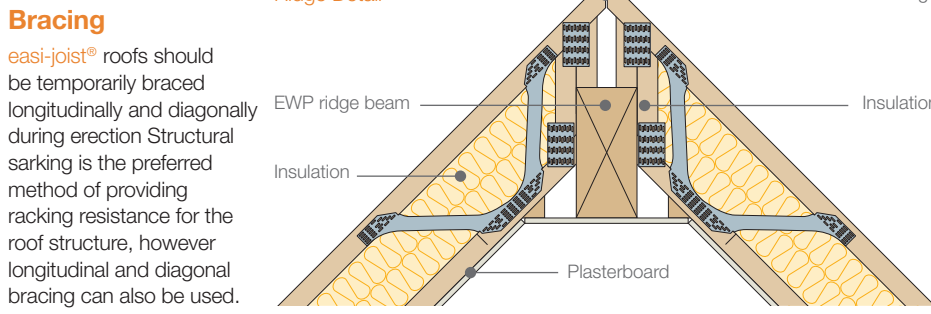

Roof Bottom Chord Restraint Detail

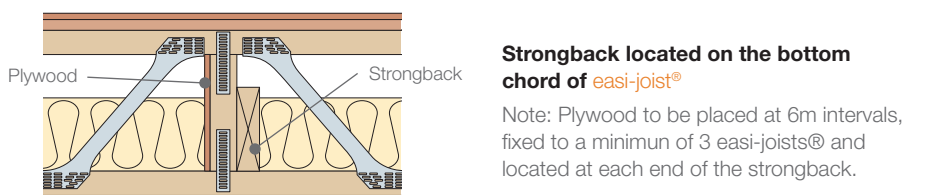
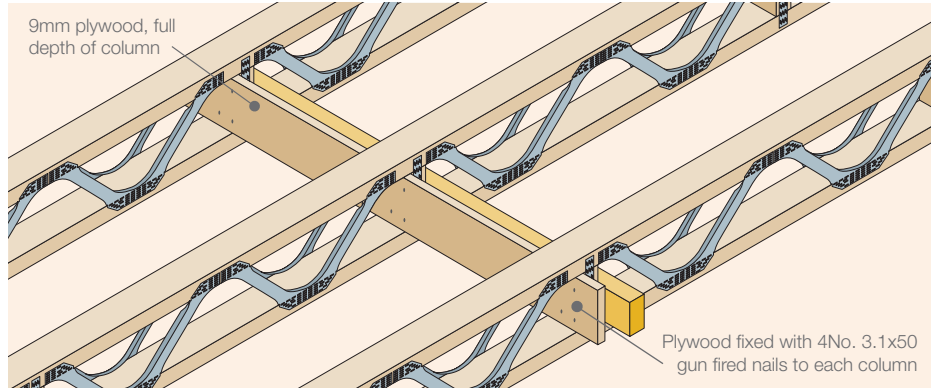

WSP00	WSP00	WSP00	WSP00	WSP00	WSP00
25 x 147 TR26	25 x 147 TR26	25 x 147 TR26	25 x 147 TR26	25 x 147 TR26	25 x 147 TR26
4.0m	4.0m	4.0m	4.0m	4.0m	4.0m
WS200 - 196	WS200 - 196	WS200 - 196	WS200 - 196	WS200 - 196	WS200 - 196
3.0m	3.0m	3.0m	3.0m	3.0m	3.0m
WS200 - 219	WS200 - 219	WS200 - 219	WS200 - 219	WS200 - 219	WS200 - 219
3.5 x 97 TR26	3.5 x 97 TR26	3.5 x 97 TR26	3.5 x 97 TR26	3.5 x 97 TR26	3.5 x 97 TR26
4.0m	4.0m	4.0m	4.0m	4.0m	4.0m
WS290	WS290	WS290	WS290	WS290	WS290
3.5 x 122 TR26	3.5 x 122 TR26	3.5 x 122 TR26	3.5 x 122 TR26	3.5 x 122 TR26	3.5 x 122 TR26
4.0m	4.0m	4.0m	4.0m	4.0m	4.0m
WS300	WS300	WS300	WS300	WS300	WS300
3.5 x 147 TR26	3.5 x 147 TR26	3.5 x 147 TR26	3.5 x 147 TR26	3.5 x 147 TR26	3.5 x 147 TR26
4.0m	4.0m	4.0m	4.0m	4.0m	4.0m
WS400	WS400	WS400	WS400	WS400	WS400
2.5 x 172 C16	2.5 x 172 C16	2.5 x 172 C16	2.5 x 172 C16	2.5 x 172 C16	2.5 x 172 C16
4.0m	4.0m	4.0m	4.0m	4.0m	4.0m

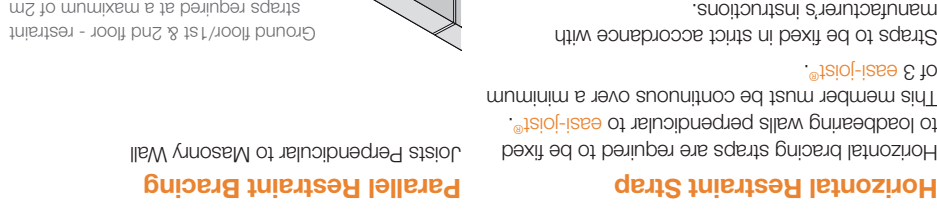
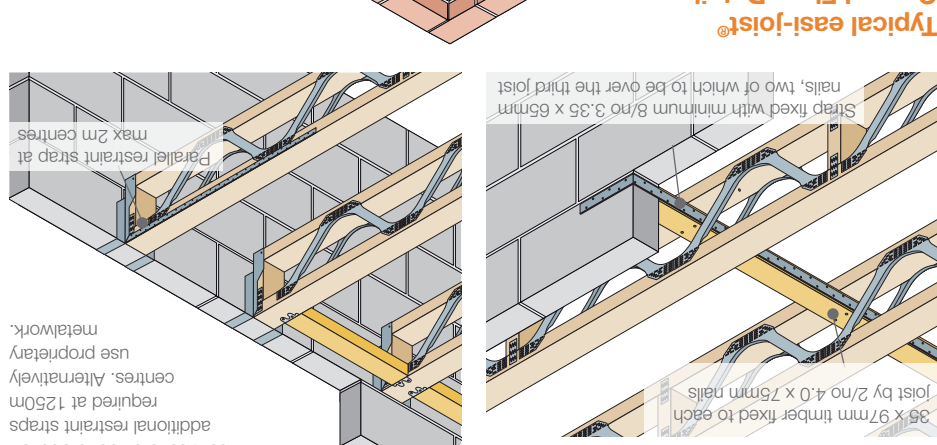
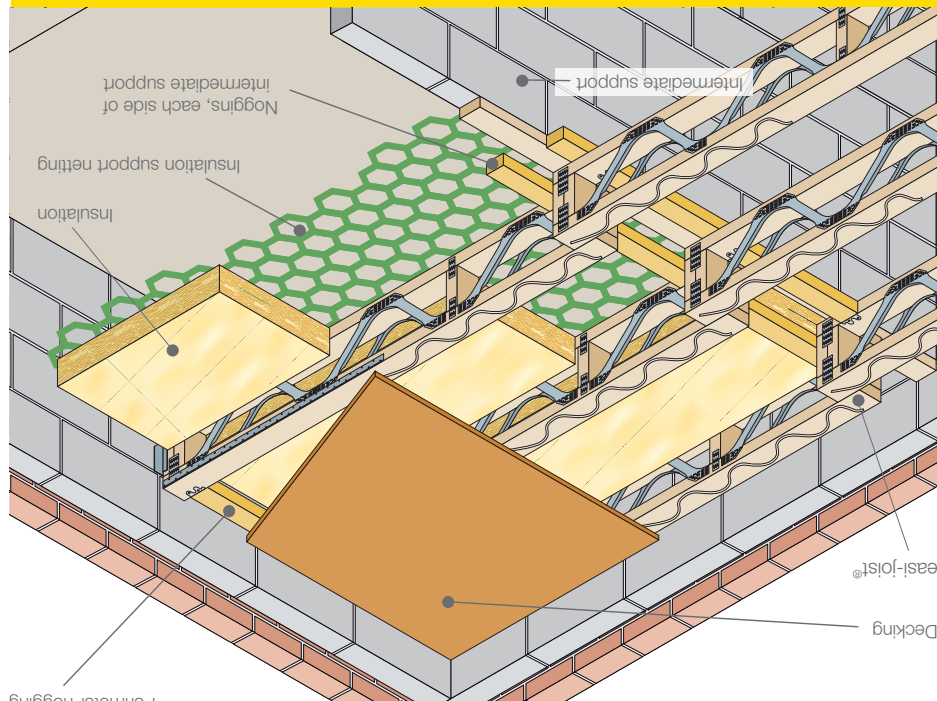

Solid Trimmable End Support

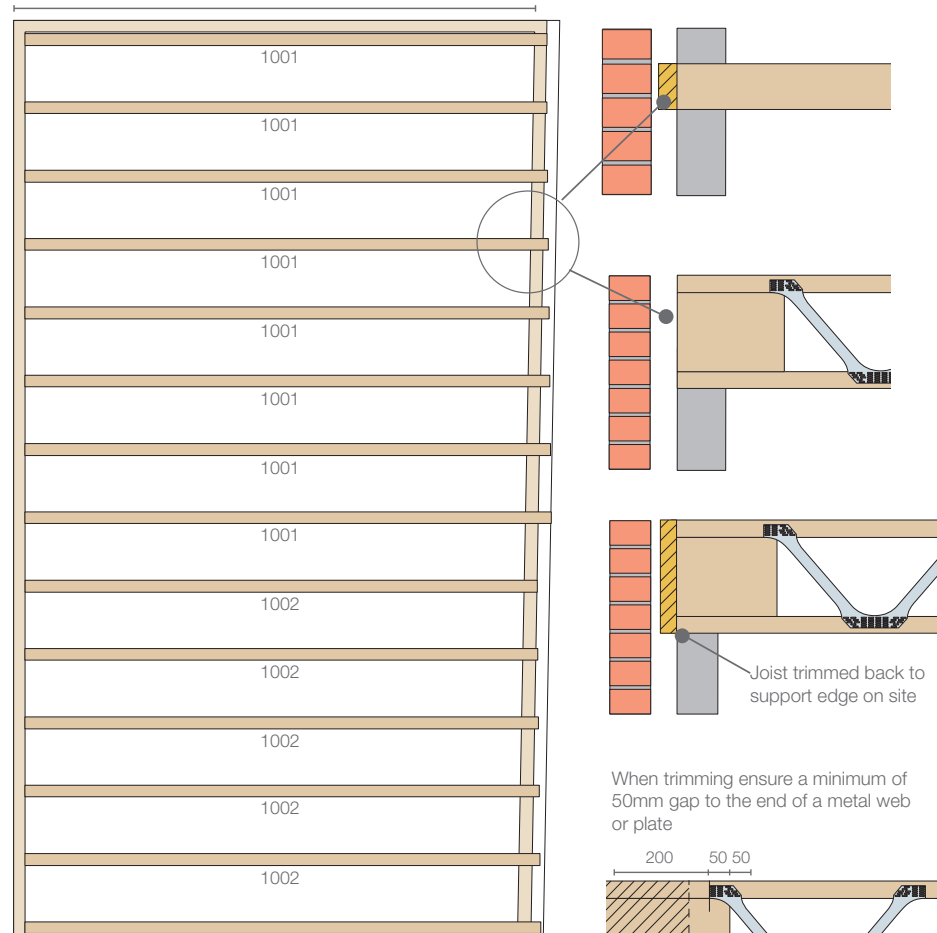

The solid trimmable end is a design solution to a problem presented by some construction projects where parallel walls are uneven. A 47mm web is fixed between the chords using 3.35mm x 65mm nails. The positioning of the nails is determined by the software and will be fixed in the factory.

Trimmable end detail has been tested to allow up to 400mm solid timber webs at each end of the joist which provides huge flexibility should a project require it. Each trimmable end joist is designed so that it can be supported along the length of the solid web section, adding to the variety of situations and effectiveness of the joists used on site. Care should be taken on site to ensure that when cutting the solid section, there is at least 50mm of timber remaining to the web to allow for the edge distance of the nails in the nailplate zone of the metalweb.

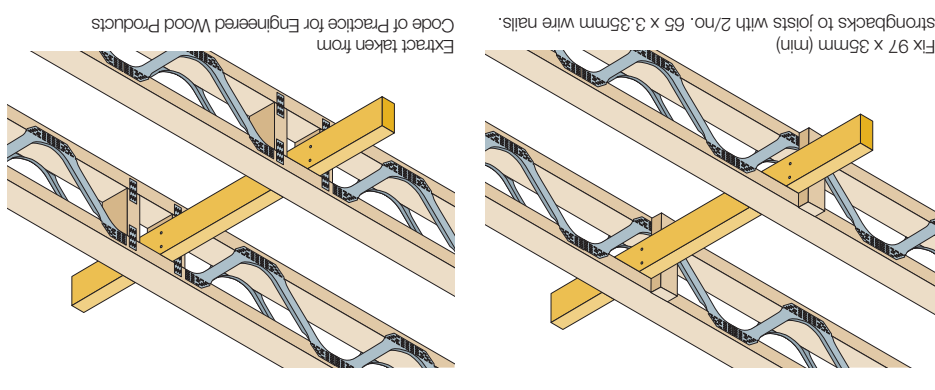

Stringback Details

Fix 5 x 38mm (min) blocks to top and bottom chords with 2/no. 65 x 3.35mm wire nails. Insert stringback through joists before fixing joists in position, as it may not be possible to do this at a later stage. Position stringback tight to underside of top flange. Fix 97 x 35mm (min) stringback to blocks with 2/no. 65 x 3.35mm wire nails.

Deflection Limits

When stringbacks are used, **easi-joist®** beams have a maximum deflection limit of 1/41mm or span x 0.003. Where spans are not provided, N/A indicates a maximum 12mm deflection limit. N/A indicates a maximum 12mm deflection limit. N/A indicates a maximum 12mm deflection limit.

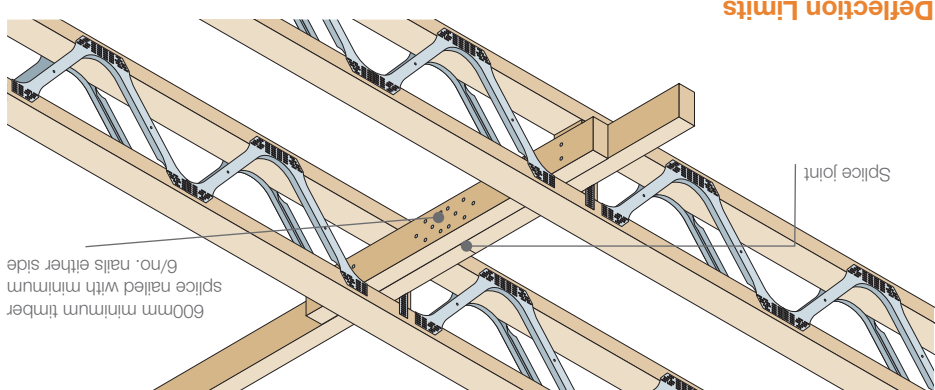

Fixing & Splicing

3.35 x 65mm nails on either side of the joint. Screwing is also satisfactory.

Stringback Sizes & Installation

Stringbacks are an essential part of the floor construction as a whole. They provide essential deflection and stiffen the floor in addition they provide a useful form of lateral bracing within the floor during its construction (see pages 24, 29 and 51 for further stringback details).

Health and Safety

Handling

- The site manager or contractor will be responsible for the handling of **easi-joist®** from the time of unloading the delivery.
- Avoid dropping, twisting or subjecting **easi-joist®** to heavy impact.
- Always lift **easi-joist®** in the upright position to prevent lateral distortion.
- Use a fabric sling for lifting joists and ensure even weight distribution.

Storage

- Storage time of **easi-joist®** prior to installation should be kept to a minimum.
- easi-joist®** should be left in bundles and remain in packaging until used.
- During this time, joists should be kept as dry as possible, and laid horizontally in an upright position, clear from the ground. Bearers should be used underneath web or column joints to prevent distortion.
- Joists are unstable until fully braced or boarded. Do not walk or store materials on an unrestrained floor area.
- Sheet materials stacked on the **easi-joist®** floor should not exceed 250mm in height and 150 kg per joist. The stack must not extend more than 1500mm from the edge of the floor with its longest span perpendicular to the joists.

Safety

- Use protective gloves when manually handling **easi-joist®**.
- Refer to plans for joist weights, remembering to account for multi-ply girders.
- Observe health and safety regulations as set out by the current standards and regulations.

Stacking Materials

IMPORTANT: It is inadvisable to stack building materials on floor joists other than floor decking as described above.

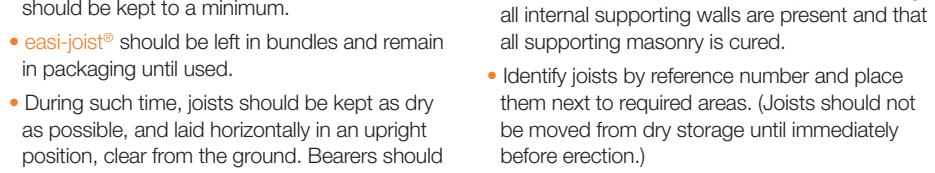

Health and Safety

Planning

- Study layout drawings and plan which section will be erected first, starting from which end. Identify girder joists and stair trimmer which will need to be installed first to provide support for others.
- Check support conditions for all joists ensuring all internal supporting walls are present and that all supporting masonry is cured.
- Identify joists by reference number and place them next to required areas. (Joists should not be moved from dry storage until immediately before erection.)

Installation

- All joists are to be installed truly vertical, parallel and top side up.
- Refer to layout plans or profiles for the correct orientation of the joist.
- Noggings, restraint straps, decking and strongbacks should be properly installed to the specification of the manufacturer or designer.
- Where masonry hangers are used, ensure at least three courses of blockwork or equivalent have been laid and the mortar cured before the floor is used.
- Spacing and loading of **easi-joist®** must not exceed that stated in the design.

Checking

- Ensure all joists are fully bearing on their supports, packing gaps if necessary.
- Check adjacent joists are level with each other and the ends of the joists form a straight line.

WSP00	WSP00	WSP00	WSP00	WSP00	WSP00
25 x 147 TR26	25 x 147 TR26	25 x 147 TR26	25 x 147 TR26	25 x 147 TR26	25 x 147 TR26
4.0m	4.0m	4.0m	4.0m	4.0m	4.0m
WS200 - 196	WS200 - 196	WS200 - 196	WS200 - 196	WS200 - 196	WS200 - 196
3.0m	3.0m	3.0m	3.0m	3.0m	3.0m
WS200 - 219	WS200 - 219	WS200 - 219	WS200 - 219	WS200 - 219	WS200 - 219
3.5 x 97 TR26	3.5 x 97 TR26	3.5 x 97 TR26	3.5 x 97 TR26	3.5 x 97 TR26	3.5 x 97 TR26
4.0m	4.0m	4.0m	4.0m	4.0m	4.0m
WS290	WS290	WS290	WS290	WS290	WS290
3.5 x 122 TR26	3.5 x 122 TR26	3.5 x 122 TR26	3.5 x 122 TR26	3.5 x 122 TR26	3.5 x 122 TR26
4.0m	4.0m	4.0m	4.0m	4.0m	4.0m
WS300	WS300	WS300	WS300	WS300	WS300
3.5 x 147 TR26	3.5 x 147 TR26	3.5 x 147 TR26	3.5 x 147 TR26	3.5 x 147 TR26	3.5 x 147 TR26
4.0m	4.0m	4.0m	4.0m	4.0m	4.0m
WS400	WS400	WS400	WS400	WS400	WS400
2.5 x 172 C16	2.5 x 172 C16	2.5 x 172 C16	2.5 x 172 C16	2.5 x 172 C16	2.5 x 172 C16
4.0m	4.0m	4.0m	4.0m	4.0m	4.0m

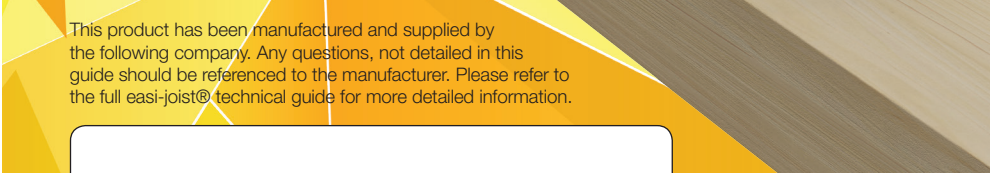
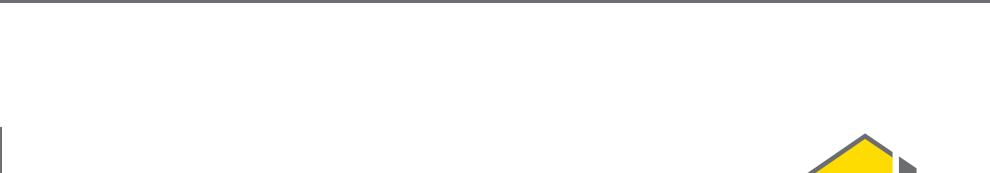
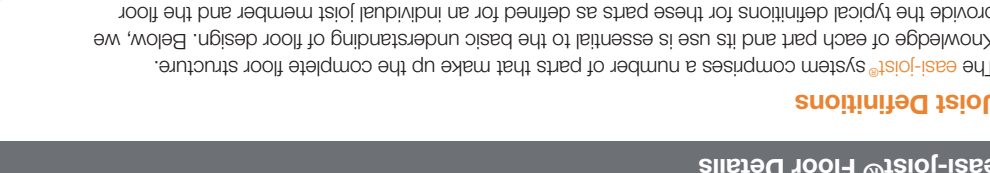
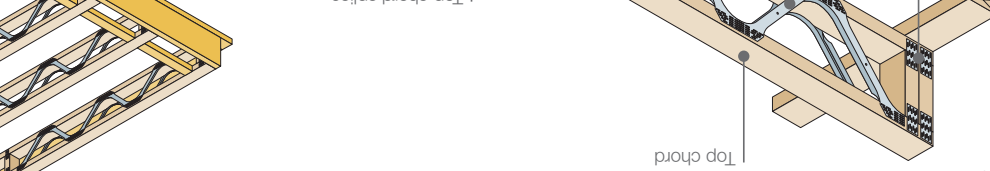
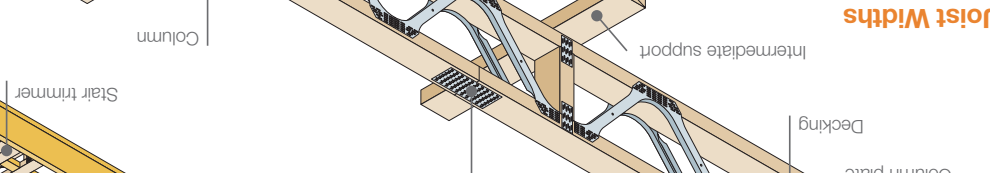
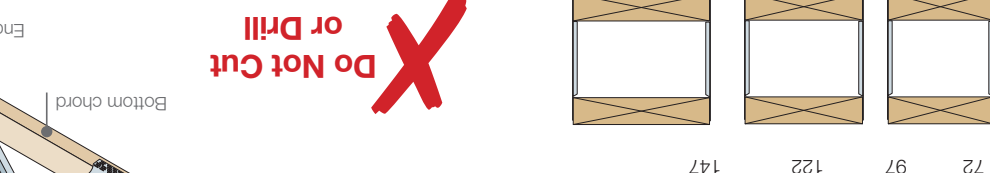
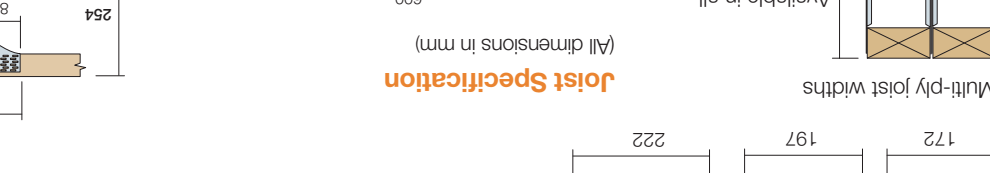
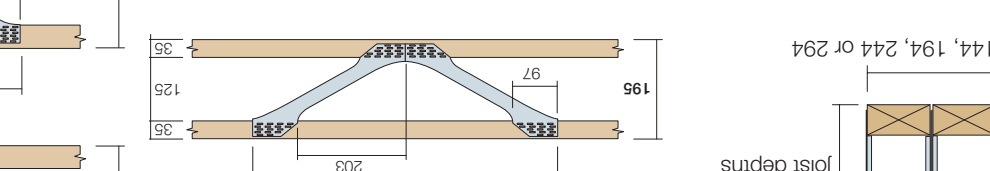
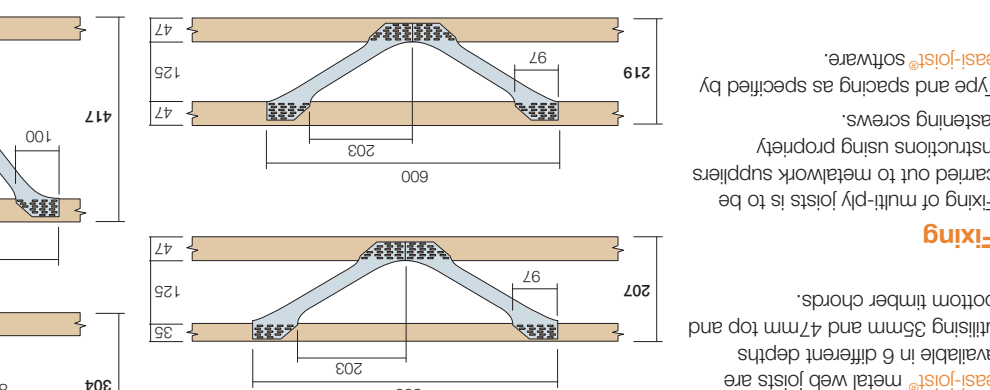
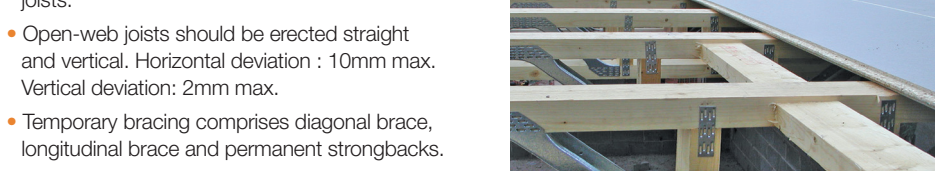
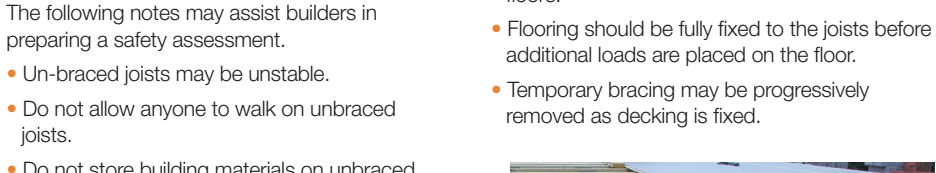
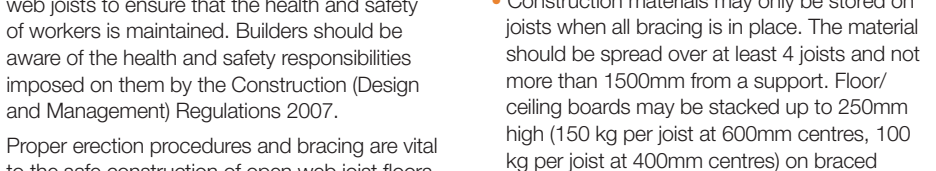
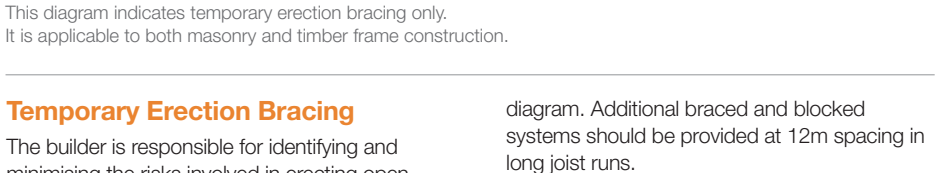
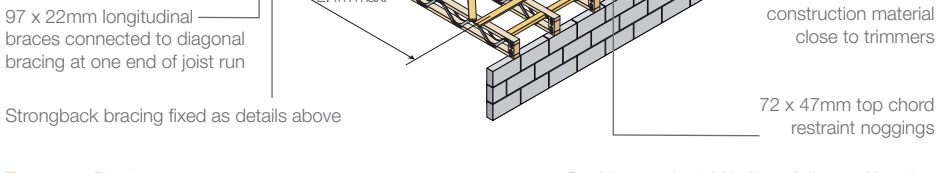
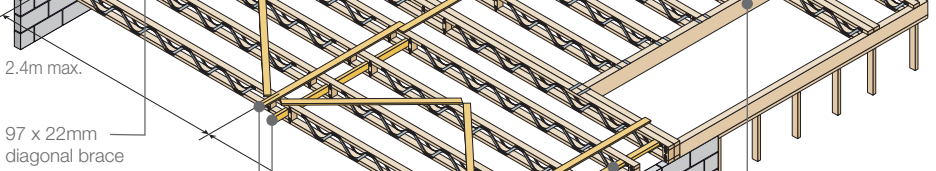
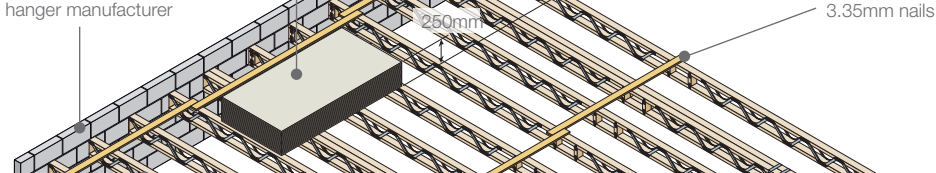
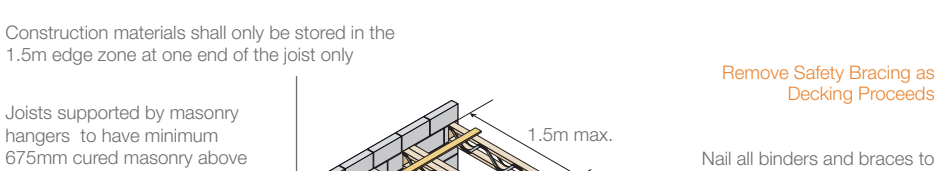
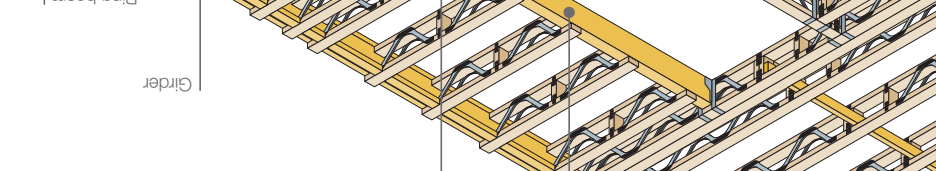
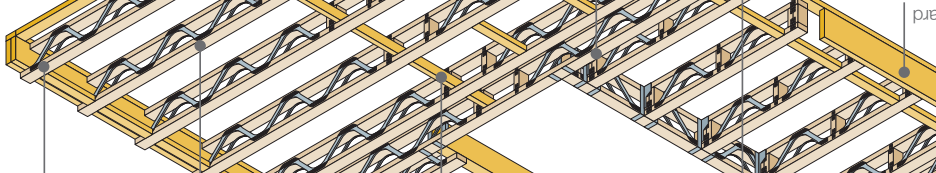
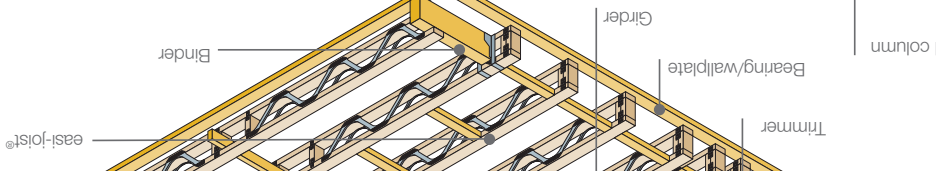
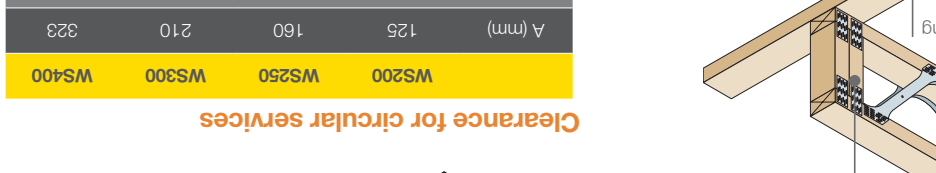
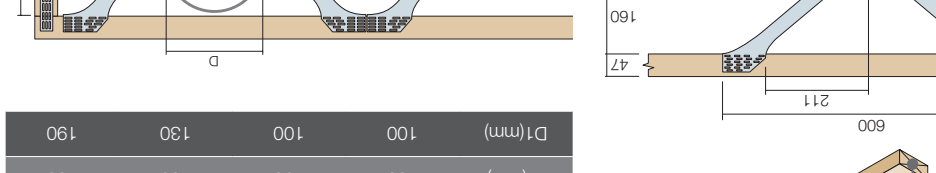
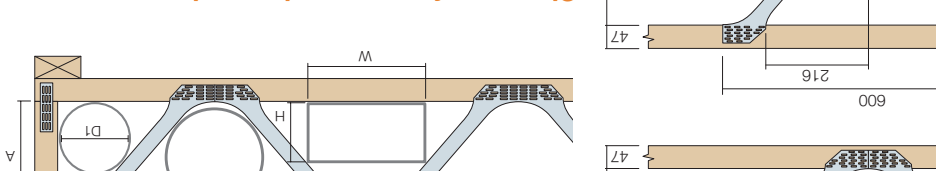

easi-joist® Floor Details

The **easi-joist®** system comprises a number of parts that make up the complete floor structure. Knowledge of each part and its use is essential to the basic understanding of floor design. Below, we provide the typical definitions for these parts as defined for an individual joist member and the floor system as a whole.

Joist Definitions

The **easi-joist®** system comprises a number of parts that make up the complete floor structure. Knowledge of each part and its use is essential to the basic understanding of floor design. Below, we provide the typical definitions for these parts as defined for an individual joist member and the floor system as a whole.

Joist Widths

Single joist widths: 72, 97, 122, 147.

Multi-joist widths: 144, 194, 244 or 294.

Joist Depths

Available in all joist depths: 196, 207, 210, 222, 224, 226, 228, 230, 232, 234, 236, 238, 240, 242, 244, 246, 248, 250, 252, 254, 256, 258, 260, 262, 264, 266, 268, 270, 272, 274, 276, 278, 280, 282, 284, 286, 288, 290, 292, 294, 296, 298, 300, 302, 304, 306, 308, 310, 312, 314, 316, 318, 320, 322, 324, 326, 328, 330, 332, 334, 336, 338, 340, 342, 344, 346, 348, 350, 352, 354, 356, 358, 360, 362, 364, 366, 368, 370, 372, 374, 376, 378, 380, 382, 384, 386, 388, 390, 392, 394, 396, 398, 400, 402, 404, 406, 408, 410, 412, 414, 416, 418, 420, 422, 424, 426, 428, 430, 432, 434, 436, 438, 440, 442, 444, 446, 448, 450, 452, 454, 456, 458, 460, 462, 464, 466, 468, 470, 472, 474, 476, 478, 480, 482, 484, 486, 488, 490, 492, 494, 496, 498, 500, 502, 504, 506, 508, 510, 512, 514, 516, 518, 520, 522, 524, 526, 528, 530, 532, 534, 536, 538, 540, 542, 544, 546, 548, 550, 552, 554, 556, 558, 560, 562, 564, 566, 568, 570, 572, 574, 576, 578, 580, 582, 584, 586, 588, 590, 592, 594, 596, 598, 600, 602, 604, 606, 608, 610, 612, 614, 616, 618, 620, 622, 624, 626, 628, 630, 632, 634, 636, 638, 640, 642, 644, 646, 648, 650, 652, 654, 656, 658, 660, 662, 664, 666, 668, 670, 672, 674, 676, 678, 680, 682, 684, 686, 688, 690, 692, 694, 696, 698, 700, 702, 704, 706, 708, 710, 712, 714, 716, 718, 720, 722, 724, 726, 728, 730, 732, 734, 736, 738, 740, 742, 744, 746, 748, 750, 752, 754, 756, 758, 760, 762, 764, 766, 768, 770, 772, 774, 776, 778, 780, 782, 784, 786, 788, 790, 792, 794, 796, 798, 800, 802, 804, 806, 808, 810, 812, 814, 816, 818, 820, 822, 824, 826, 828, 830, 832, 834, 836, 838, 840, 842, 844, 846, 848, 850, 852, 854, 856, 858, 860, 862, 864, 866, 868, 870, 872, 874, 876, 878, 880, 882, 884, 886, 888, 890, 892, 894, 896, 898, 900, 902, 904, 906, 908, 910, 912, 914, 916, 918, 920, 922, 924, 926, 928, 930, 932, 934, 936, 938, 940, 942, 944, 946, 948, 950, 952, 954, 956, 958, 960, 962, 964, 966, 968, 970, 972, 974, 976, 978, 980, 982, 984, 986, 988, 990, 992, 994, 996, 998, 1000.

Joist Spacing

Available in all joist spacings: 300, 330, 360, 390, 420, 450, 480, 510, 540, 570, 600, 630, 660, 690, 720, 750, 780, 810, 840, 870, 900, 930, 960, 990, 1020, 1050, 1080, 1110, 1140, 1170, 1200, 1230, 1260, 1290, 1320, 1350, 1380, 1410, 1440, 1470, 1500, 1530, 1560, 1590, 1620, 1650, 16

GENERAL DETAILS

G1 • Face Fix Hanger

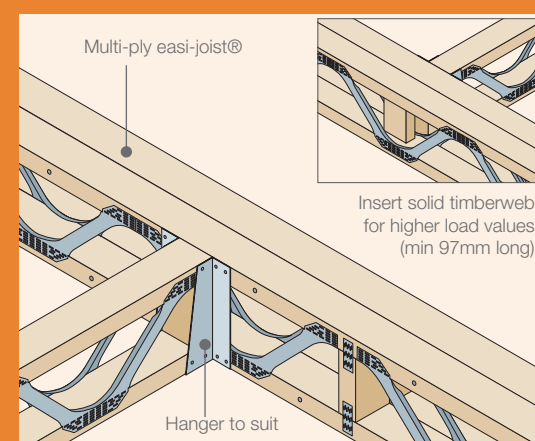

G8 • Strongback

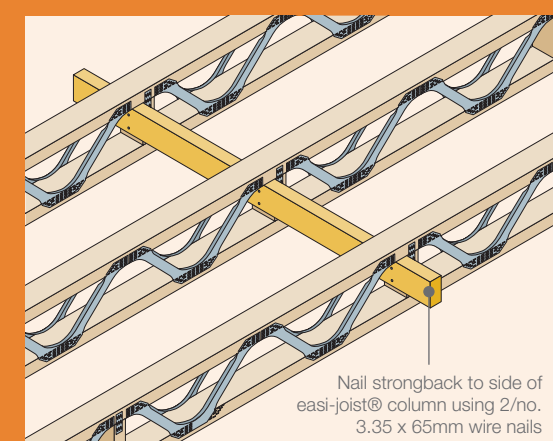

G11 • Joist on I-Beam with Hidden Support

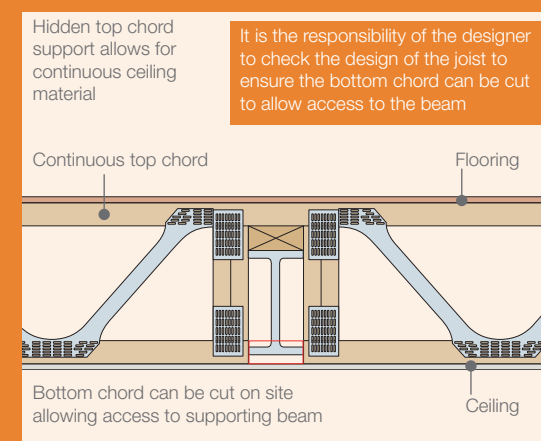

G12 • Cantilevered Joists

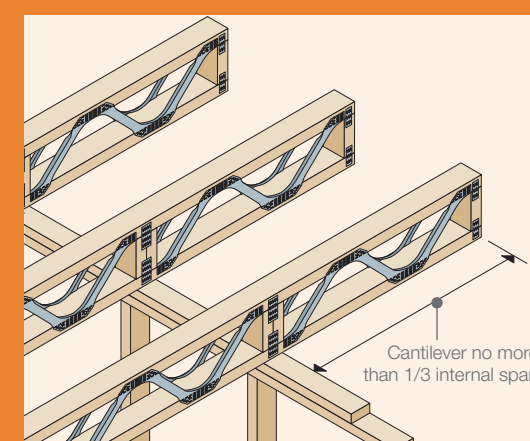

G2 • Strap Hanger

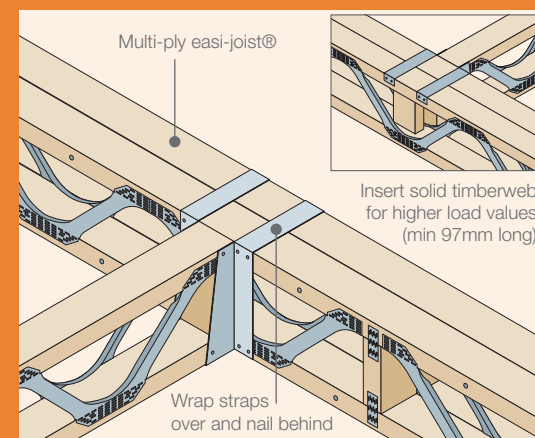

G3 • Stair Opening with easi-joist®

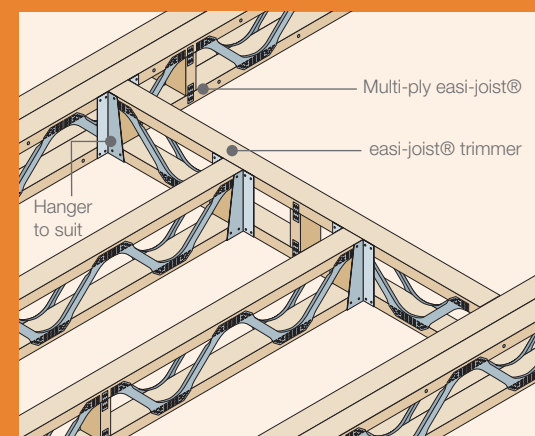

G4 • Stair Opening with Binder

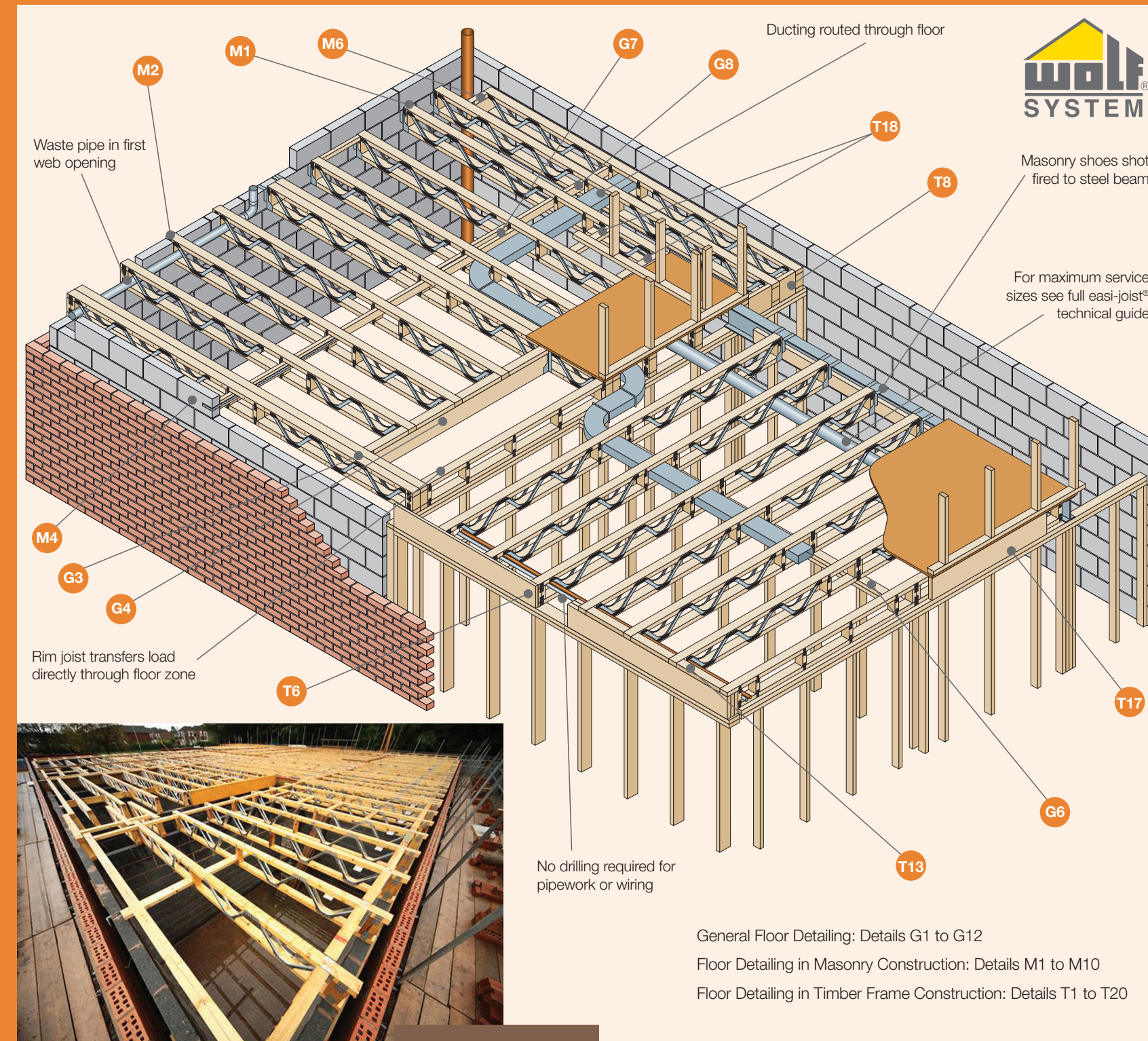
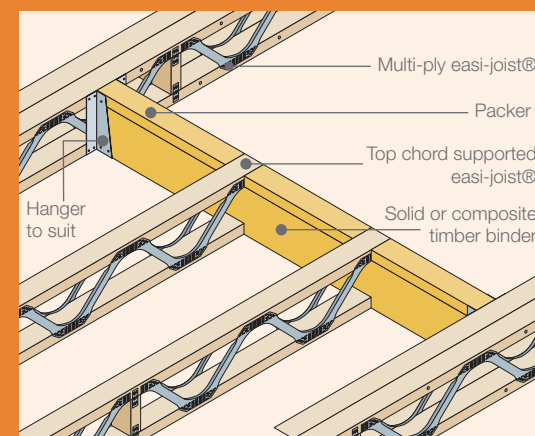

MASONRY DETAILS

G5 • Intermediate Support (on to block wall)

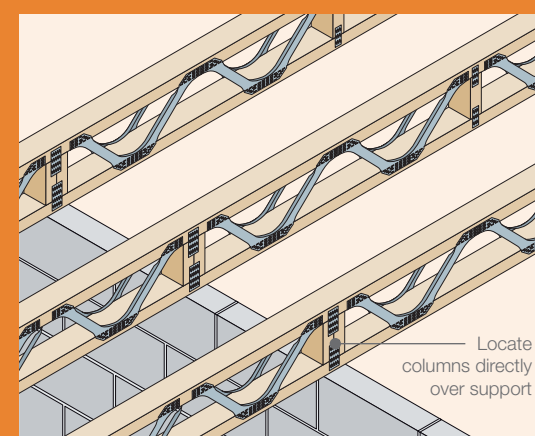

G9 • Strongback Splice

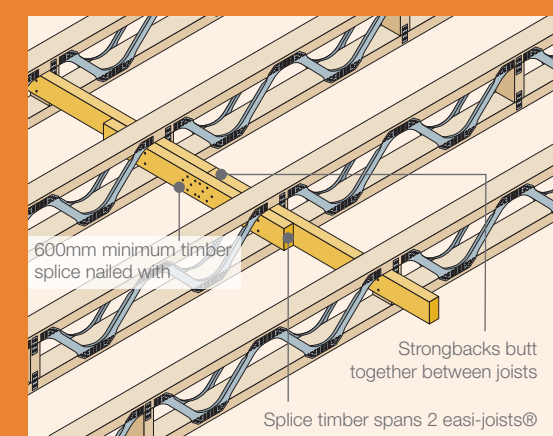

G6 • Intermediate Support (on to stud wall)

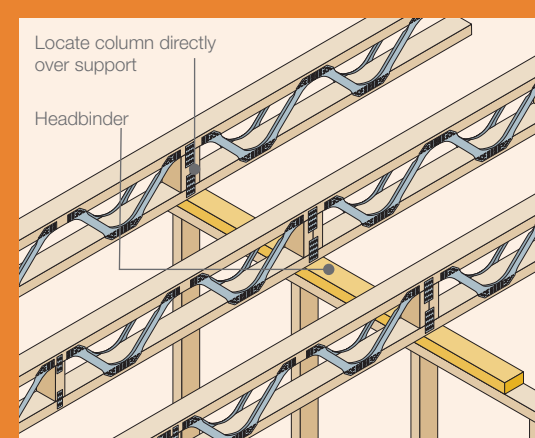

G10 • Top Chord Support on to Steel

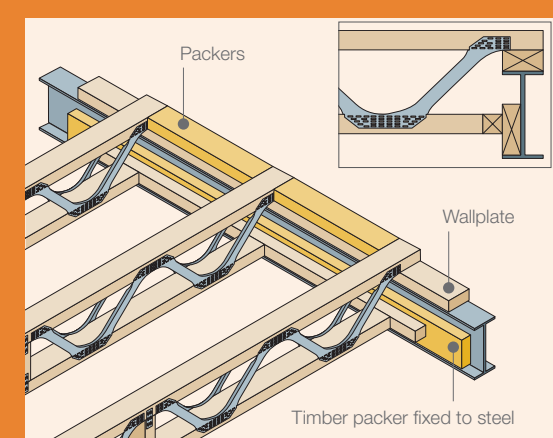

G7 • Strongback Lapping

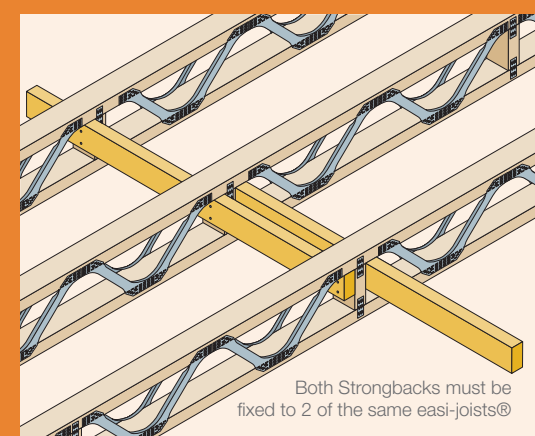

M1 • SVP with Narrow Chord End Joist

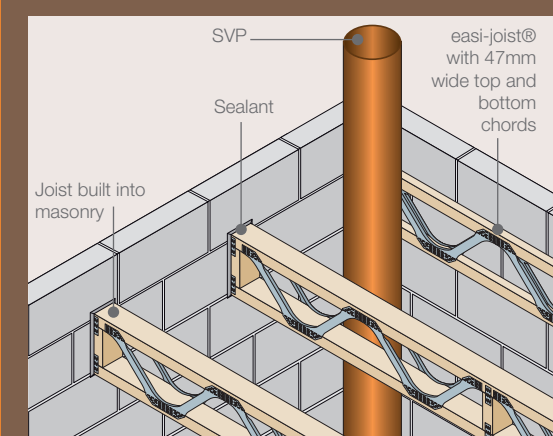

M2 • Bottom Chord Support Built In

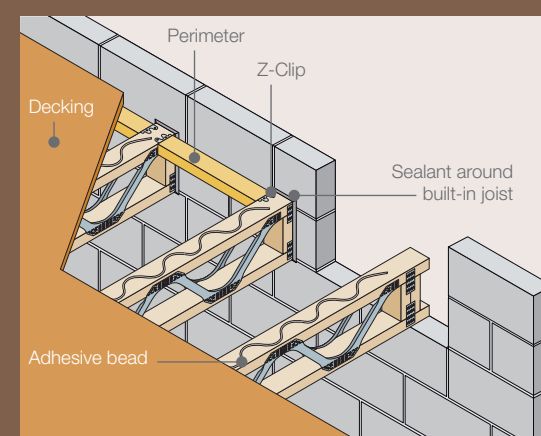

M5 • Lateral Restraint Bracing

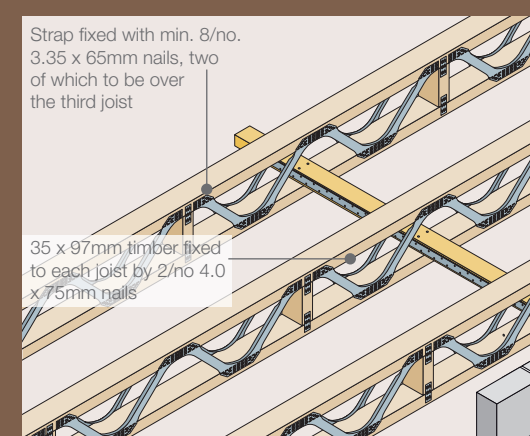

M8 • Parallel Restraint Bracing - Opening greater than 600mm

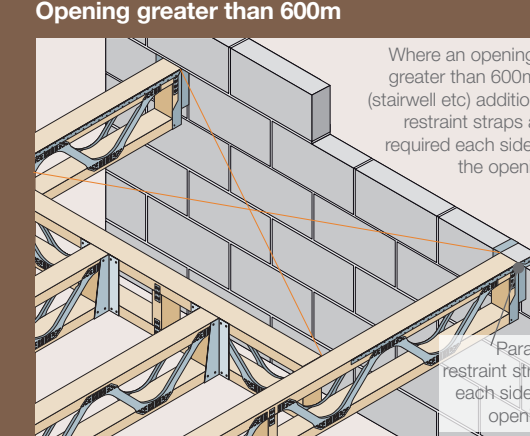

M3 • Parallel Restraint Bracing - Joists Perpendicular to Masonry Wall

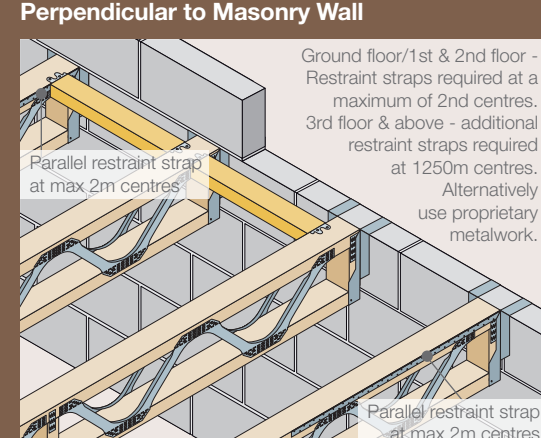

M6 • SVP with Trimmer

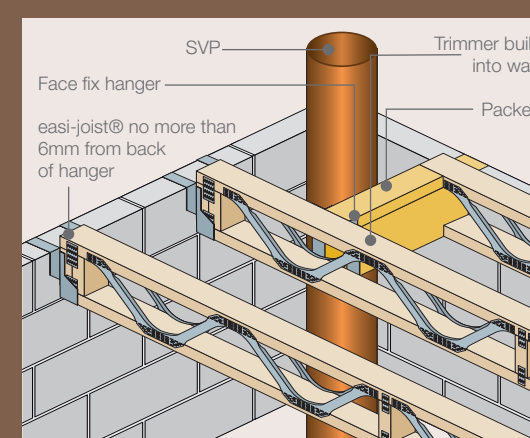

M9 • Hangers with Noggings and Parallel Restraint Straps

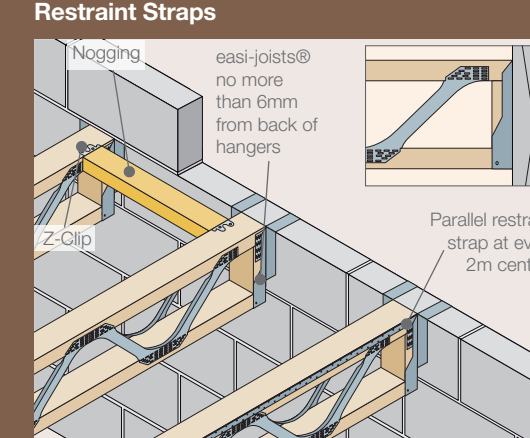

M4 • Lateral Restraint of Strongback

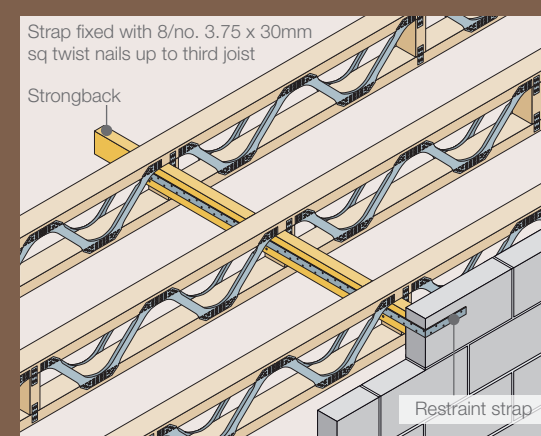

M7 • Solid Timber Web over Intermediate Support

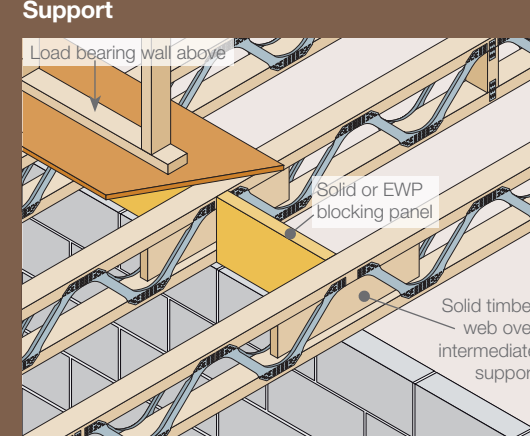

M10 • Bottom Chord Support Built in with Solid Timber Web Trimmable End

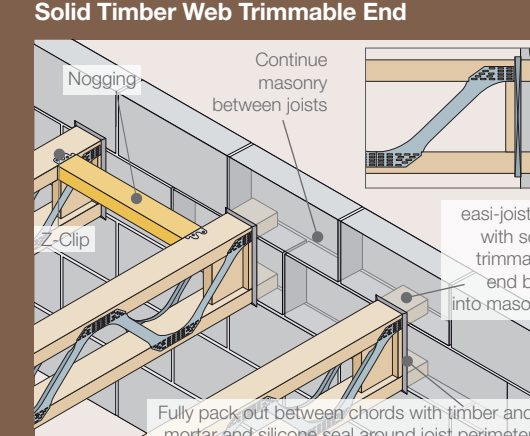

TIMBER DETAILS

T1 • Internal Wall Lapped Joists

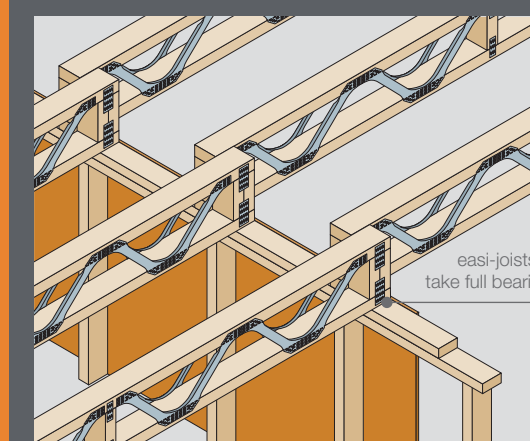

T5 • Bottom Chord Support with Trimmable End and Rimboard

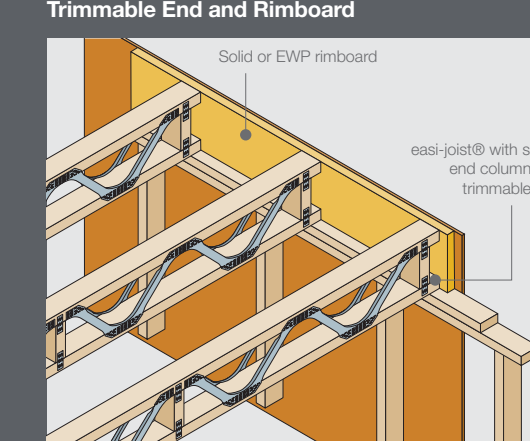

T9 • Top Chord Support

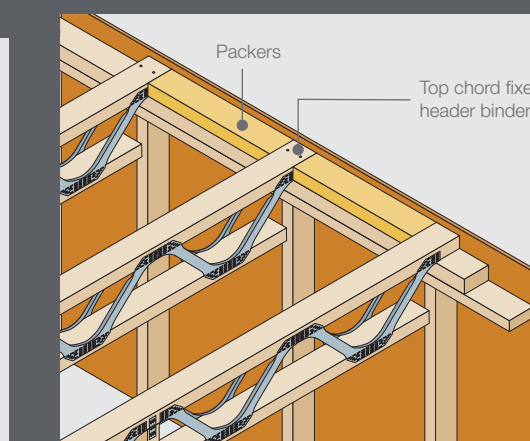

T13 • Top Chord Support on Ring Beam

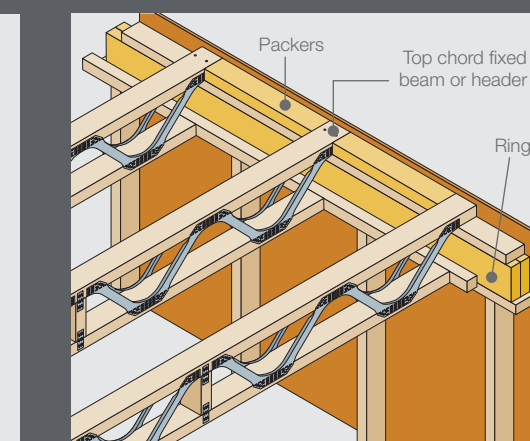

T17 • Proposed Arrangement for Timber Frame Construction

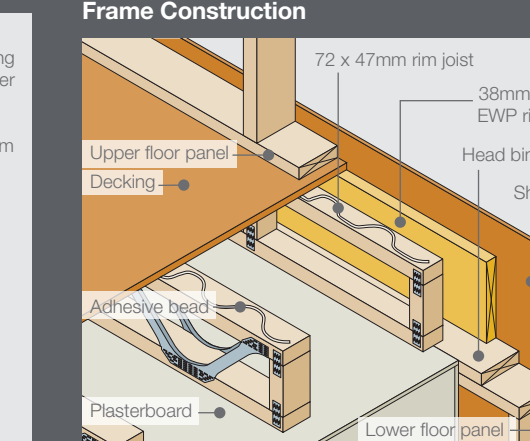

T2 • Internal Wall Butted Joists

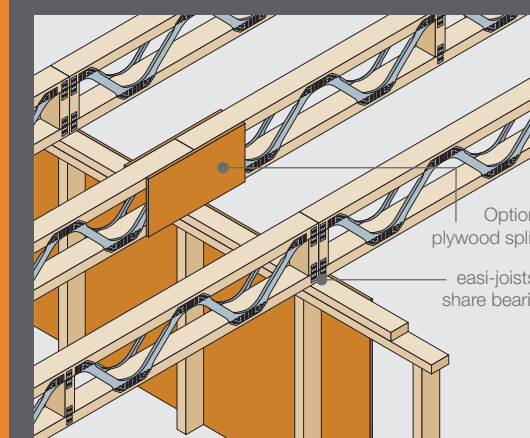

T6 • Bottom Chord Support with Rimboard Closure

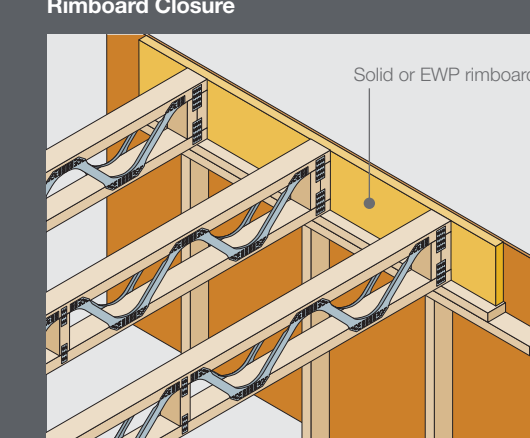

T10 • Top Chord Support with End Column

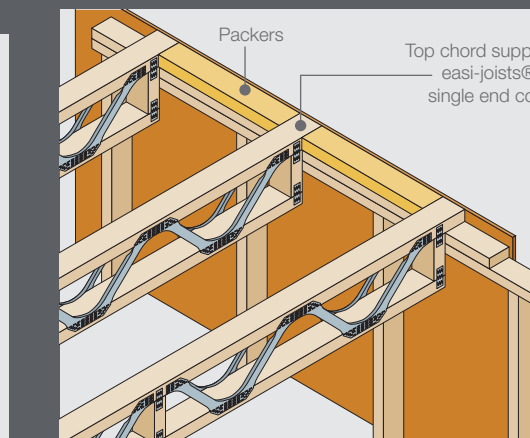

T14 • Proposed Arrangement for Timber Frame Construction

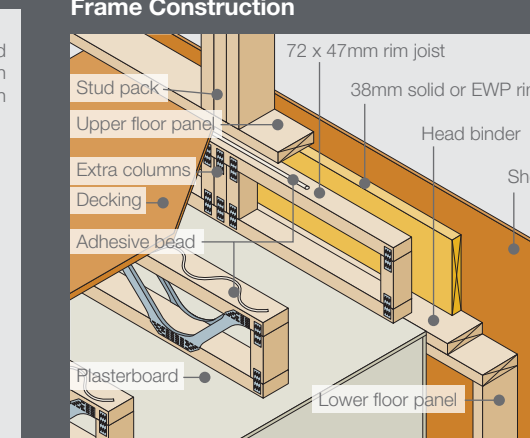

T18 • Non-Load Bearing Wall Support Parallel with Joists

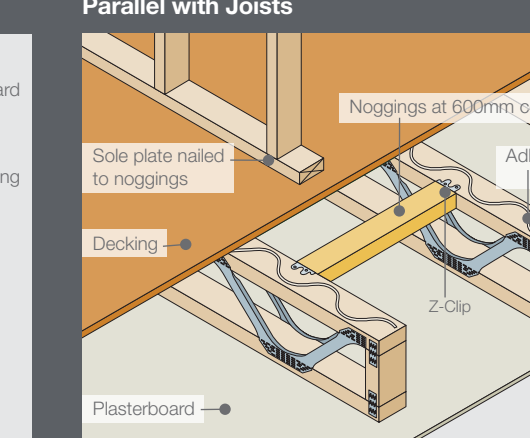

T3 • Intermediate Support Bearing Over Stud Wall

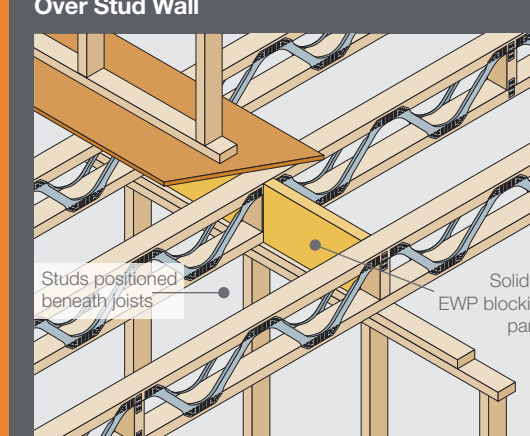

T7 • Bottom Chord Support with Restraint Nogging

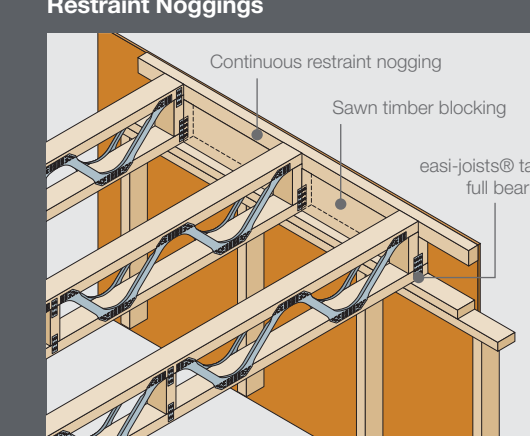

T11 • Bottom and Top Chord Support with EWP Rimboard

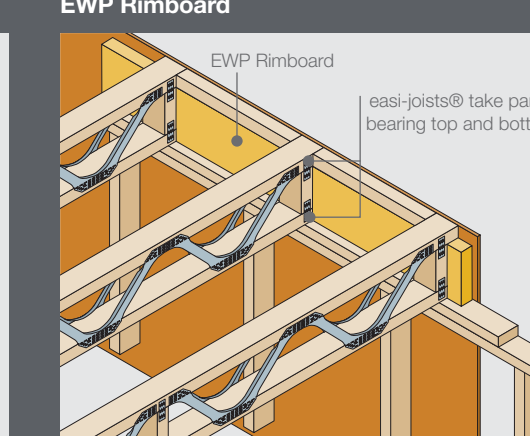

T15 • Proposed Arrangement for Timber Frame Construction

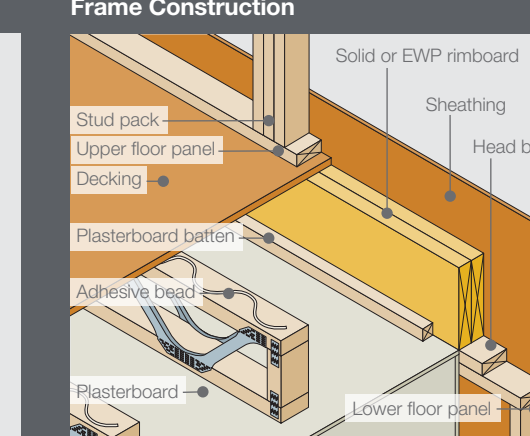

T19 • Internal Wall Lap Support

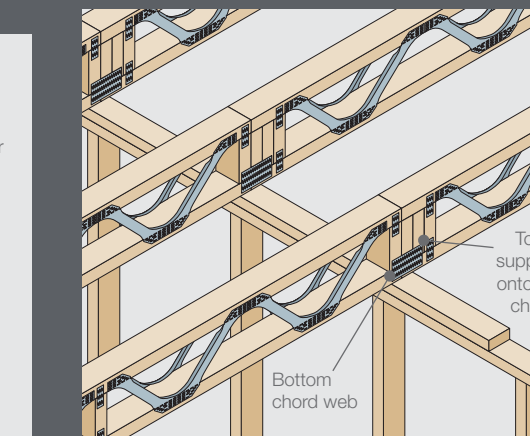

T4 • Intermediate Support (on to stud wall)

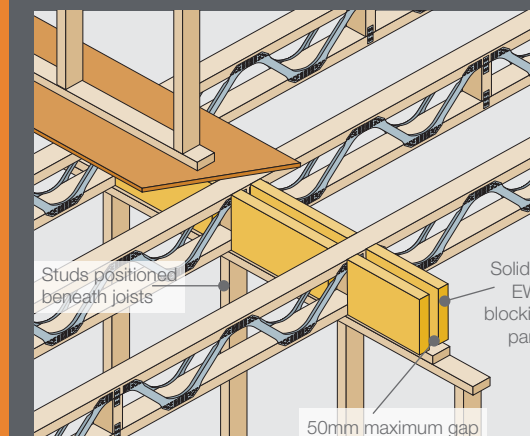

T8 • Bottom Chord Support with Full Height Blocking

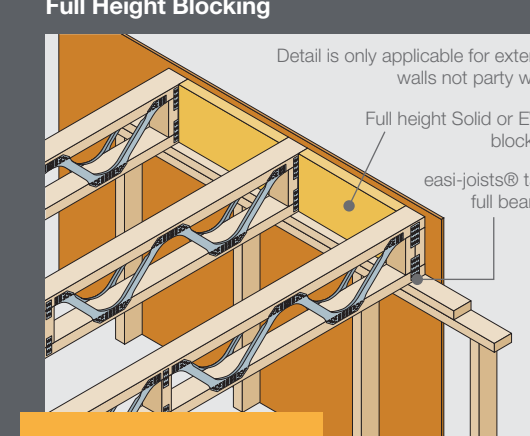

T12 • Top Chord Support with Double Rimboard

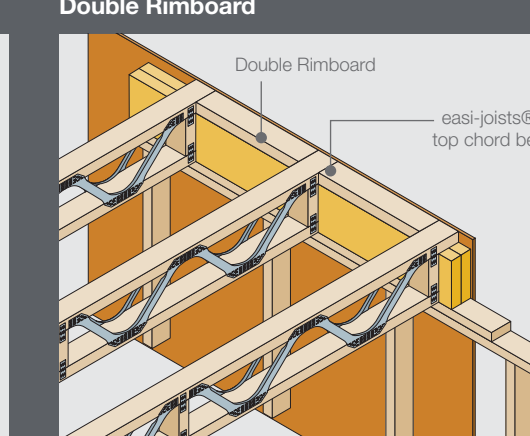

T16 • General Arrangement for Timber Frame Construction

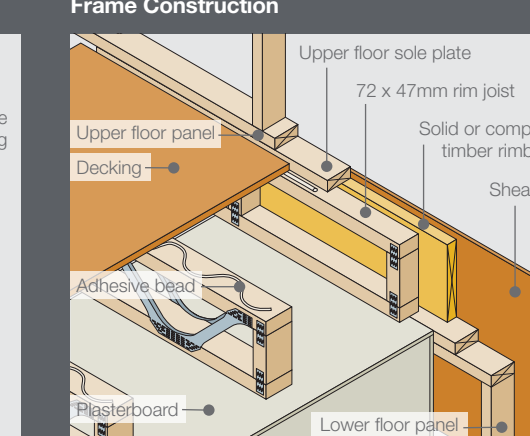

T20 • Solid Timber Web over Intermediate Support Stud positioned beneath Joists

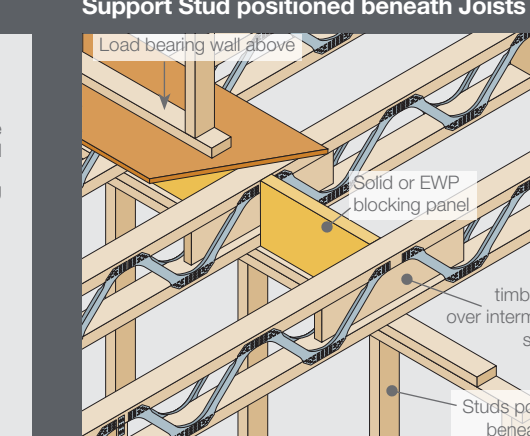

easi-rafter® DETAILS

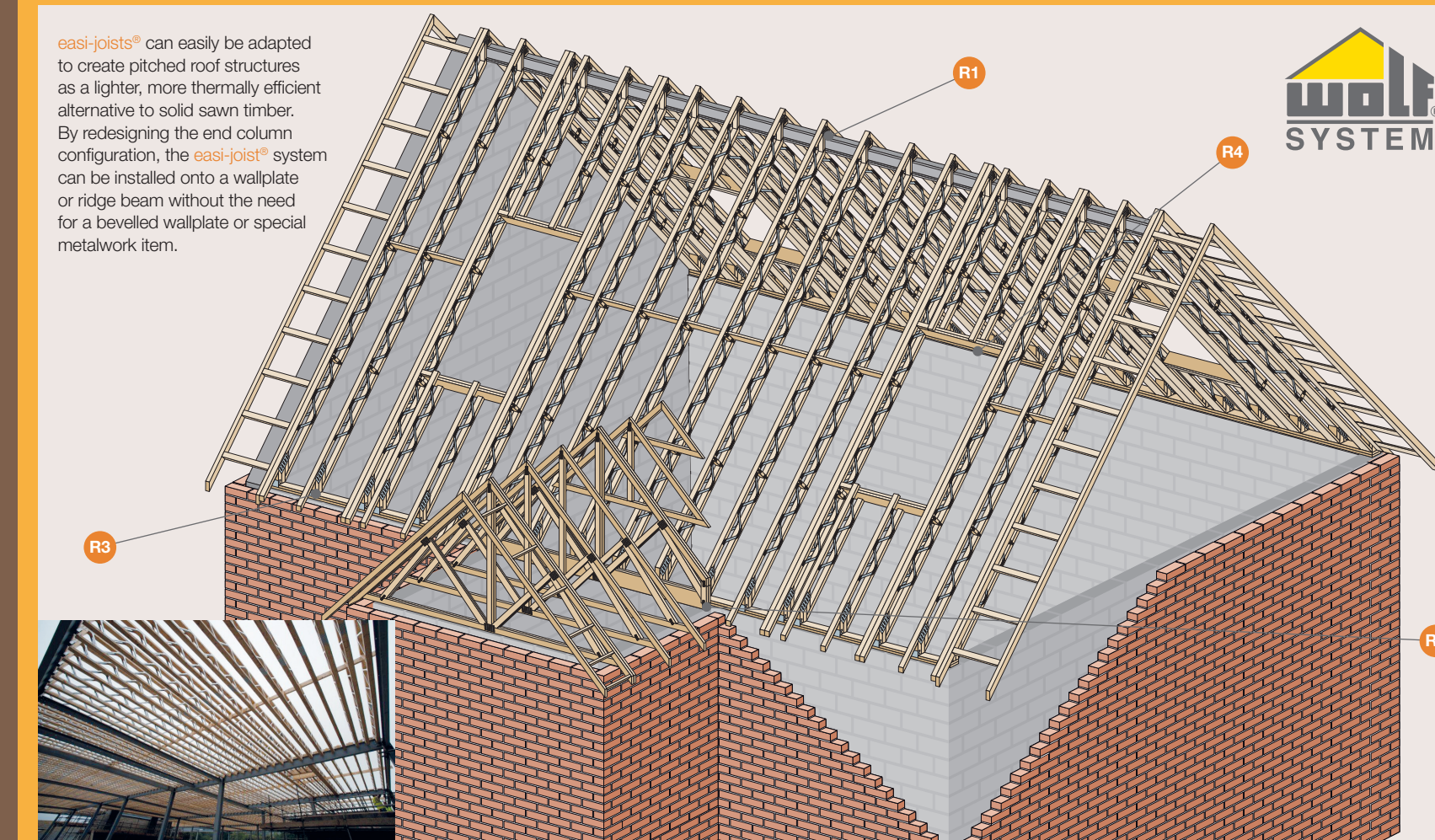

R6 • Typical Eaves Detail

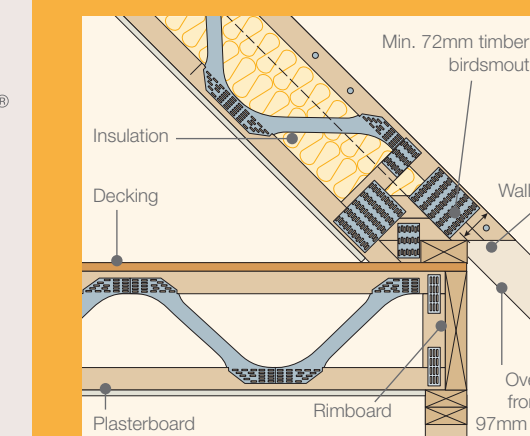

R5 • Typical Rafter Detail

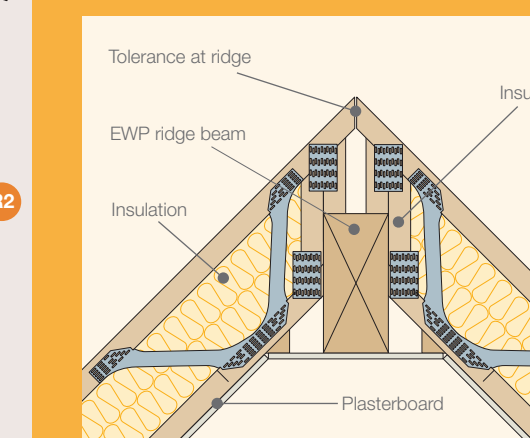

R1 • easi-rafter® Ridge Detail

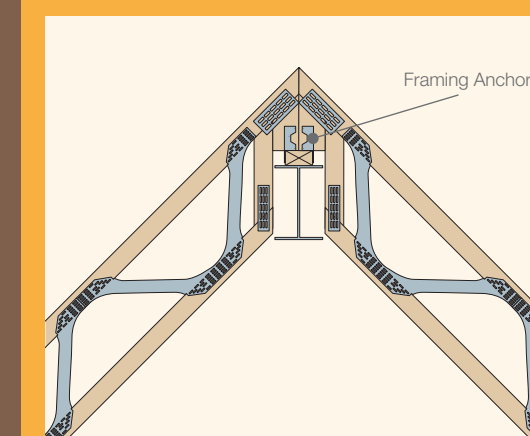

R2 • easi-rafter® Hanger Detail

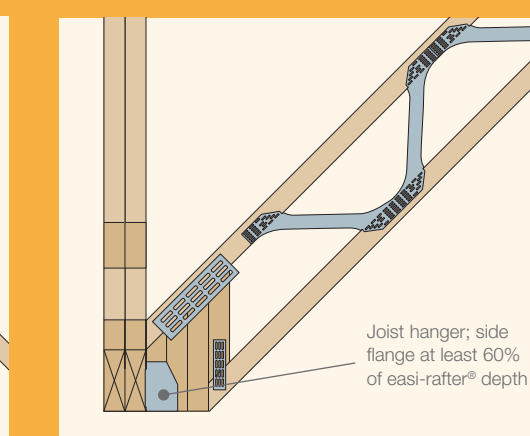

R3 • Typical easi-rafter® Heel

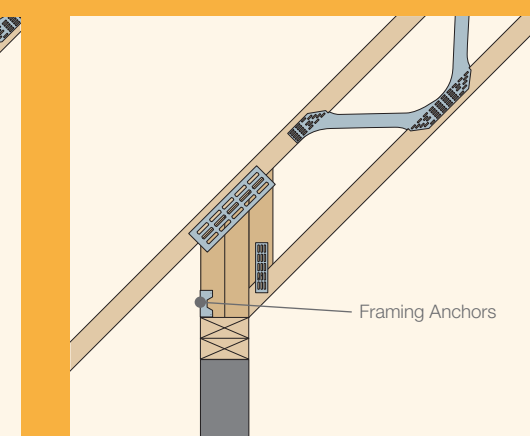

R4 • easi-rafter® Opening

